

## HTU31D RH/T SENSOR IC

### Digital Relative Humidity sensor with Temperature output

#### Characteristics

- Fully calibrated, temperature compensated
- Voltage supply range from 3V to 5.5V
- Typical accuracy  $\pm 2\%RH$  and  $\pm 0.2^{\circ}C$
- Fast response time
- Compact 6-Pin DFN package
- Fast I<sup>2</sup>C interface with 2 configurable addresses
- Qualified according to AEC Q100 grade 1 standard
- Typical power consumption down to 3.78 $\mu$ W

#### Key Features

- High reliability and environmental robustness
- Full interchangeability with no calibration required in standard conditions
- Quick recovery after long periods in saturation phase
- Compatible with automatic assembly processes
- Reflow solderable
- Individual marking for compliance to stringent traceability requirements
- Lead free sensor
- Low power consumption

#### Applications

- Home Appliance
- Medical
- Printers
- Humidifier
- Automotive
- Meteorology
- Environmental Monitoring

#### General description

Today's demand for energy efficient sensors in appliance, consumer, industrial, and medical applications require optimal system performance to meet environmental and end user expectations.

The HTU31 is one of the smallest and most accurate humidity sensors on the market. Our precision engineering and 20+ years of experience in humidity and temperature combination sensors, enables us to provide fast response time, precision measurement, low hysteresis and sustained performance even when exposed to extreme temperature ( $-40^{\circ}$  to  $125^{\circ}C$ ) and humidity environments (0%-100%).

The HTU31 humidity sensor includes both digital (D) and analog (V) versions, and combines multiple functions and various interfaces (I<sup>2</sup>C, analog, voltage output) with an application-friendly operating voltage range (3.3-5.5V with 5V typical). The HTU31 humidity and temperature sensor is available in small and large volumes to meet the ever-changing demands of our customers.

## PERFORMANCE SPECIFICATION

### Performance Specifications (Humidity)

@25°C, Vdd=5V

Characteristics	Condition	Value	Units	Notes / Conditions
Humidity Operating Range	Max <sup>1</sup>	0 to 100	%RH	
Relative Humidity Accuracy	Typical	±2	%RH	Figure 1 Humidity sensor rating @25°C
Resolution	Typical	0.01	%RH	Table 11 Humidity and Temperature conversion parameters
Hysteresis	@25°C	±0.7	%RH	
Response Time <sup>2</sup>	$\tau_{63\%}$	5	s	
Recovery time after 150 hours of condensation	Typical	10	s	
Long term drift <sup>3</sup>	Typical	0.5	%RH/yr	

Table 1 Humidity sensor specification

### Performance Specifications (Temperature)

Characteristics	Condition	Value	Units	Notes / Conditions
Temperature Operating Range		-40 to 125	°C	
Temperature Accuracy	Typical	±0.2	°C	Figure 2 Temperature sensor rating
Resolution	Typical	0.016	°C	Table 11 Humidity and Temperature conversion parameters
Response Time <sup>2</sup>	$\tau_{63\%}$	10	s	
Long term drift <sup>3</sup>	Typical	0.04	°C/yr	

Table 2 Temperature sensor specification

<sup>1</sup> See Figure 3 Humidity and Temperature operating range

<sup>2</sup> Under 1 m.s-1 air flow

<sup>3</sup> Typical application mean that see regular environmental variation within optimum measurement range.

### Humidity sensor rating

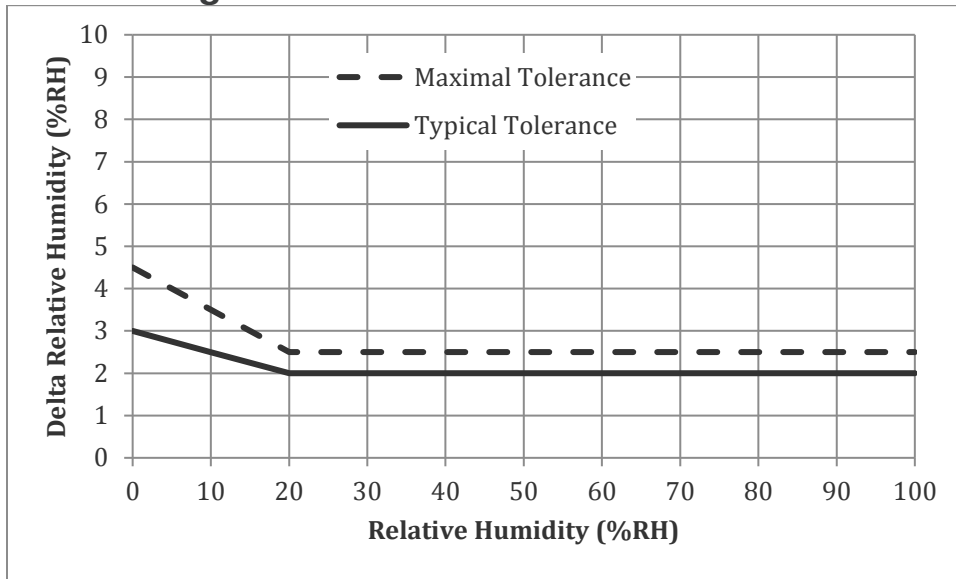

Figure 1 Humidity sensor rating @25°C

### Temperature sensor rating

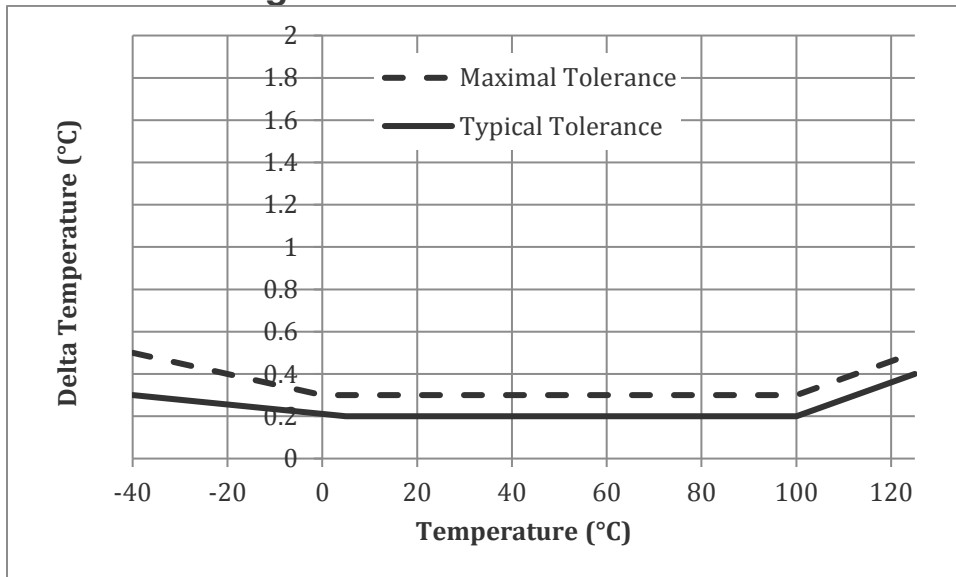

Figure 2 Temperature sensor rating

## SENSOR INTEGRATION

### Absolute Maximum rating

Ratings	Symbol	Value	Unit	Notes / Conditions
Storage Temperature <sup>4</sup>	Tstg	-40 to 150	°C	
Supply Voltage (Peak)	Vcc	6V	Vdc	
Humidity Operating Range	RH	0 to 100	%RH	
Temperature Operating Range	Ta	-40 to +125	°C	
VDD to GND		-0.3 to 6V	V	
Digital I/O pins (DATA/SCK) to VDD		-0.3 to VDD+0.3	V	
ESD HBM (human body model) <sup>5</sup>		±4	kV	
ESD Charged device model <sup>6</sup>		750	V	
ESD Machine model <sup>7</sup>		±200	V	

Table 3 Maximum Rating

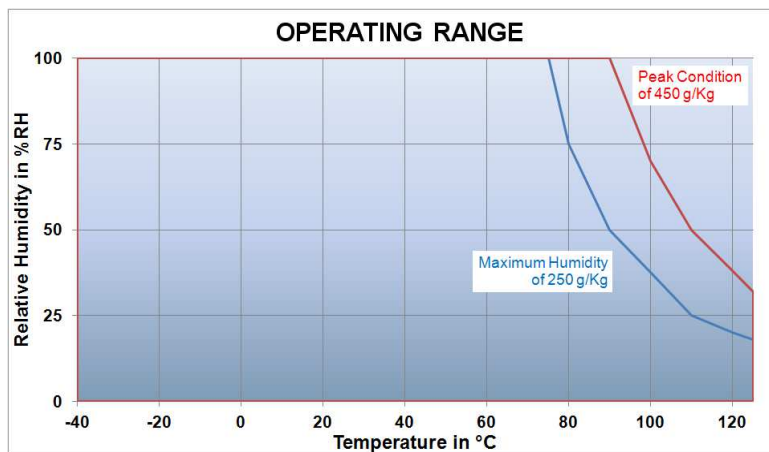

Figure 3 Humidity and Temperature operating range

The sensor should operate at peak condition less than 10% of the operating life. Exposure to absolute maximum rating conditions for extended periods may temporarily offset RH measurement (+5%RH above accuracy specification, that slowly will recover over time) and accelerate its ageing.

<sup>4</sup> Sensor in specification after 1000h storage @150°C

<sup>5</sup> According to ANSI/ESDA/JEDEC JS-001-2014; AEC-Q100-002.

<sup>6</sup> ESDA ESD-STM5.3.1-1999 and AEC-Q100-011 (charged device model, 750V corner pins, 500V other pins)

<sup>7</sup> JEDEC JESD22-A115 method (Machine Model ±200V)

## Electrical specification

 $V_{dd} = 5V @25^{\circ}C$ 

Characteristics	Symbol	Min	Typ	Max	Unit	Notes / Conditions
Voltage Supply	$V_{dd}$	3.0	5.0	5.5	V	
Current consumption	$i_{dd}$		0.05	0.20	$\mu A$	Sleep mode
				450	$\mu A$	Measuring
Power Dissipation			0.25	1	$\mu W$	Sleep mode
			3.78		$\mu W$	Typical <sup>8</sup>
				2.25	mW	Measuring
Heater	$R_{heat}$	1.5	2.0	2.5	k $\Omega$	$P_{heat} = \frac{V_{dd}^2}{R_{heat}}$
	$P_{heat}$	10	12.5	16	W	

Table 4 Electrical specification

## Timing specification for sensor

Characteristics	Symbol	Min	Typ	Max	Unit	Notes / Conditions
Power up time				10	ms	
Soft reset time				15	ms	
Duration of reset pulse			2		ms	
Humidity conversion time	$T_{conv\ hum}$		8.34		ms	Humidity OSR = 3 (0.007%RH)
			4.21		ms	Humidity OSR = 2 (0.010%RH)
			2.14		ms	Humidity OSR = 1 (0.014%RH)
			1.11		ms	Humidity OSR = 0 (0.020%RH)
Temperature conversion time	$T_{conv\ temp}$		11.98		ms	Temperature OSR = 3 (0.012°C)
			6.03		ms	Temperature OSR = 2 (0.016°C)
			3.06		ms	Temperature OSR = 1 (0.025°C)
			1.57		ms	Temperature OSR = 0 (0.040°C)

Table 5 Timing specification@25°C Vdd = 5V

<sup>8</sup> 1 measurement RH and temperature per second, OSR0

## INTERFACES

### PIN assignment

N°	Function	Comment
1	SDA	Serial Data Output / Input
2	GND	Ground
3	IC_Add	Address selection
4	RST	Reset Pin
5	VDD	Supply voltage
6	SCL	Clock

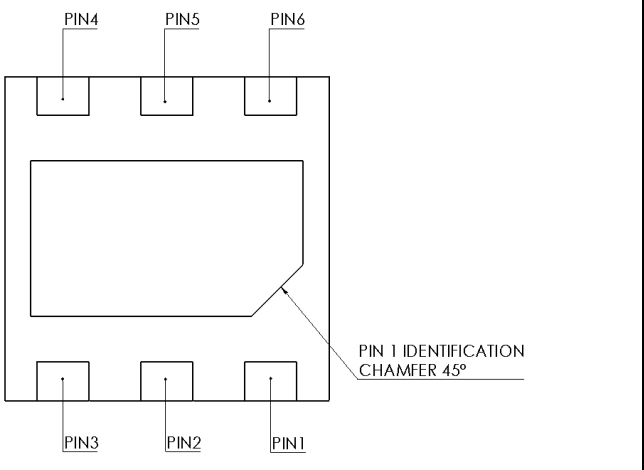

Table 6 Pin Assignment

### Communication Pins (SDA / SCL)

SCL is used to synchronize the communication between microcontroller and HTU31D sensor. Since the interface consists of fully static logic there is no minimum SCL frequency

The DATA pin is used to transfer data in and out of the device. For sending a command to the HTU31D sensor, DATA is valid on the rising edge of SCL and must remain stable while SCL is high. After the falling edge of SCL, the DATA value may be changed. For safe communication DATA shall be valid  $t_{QS}$  and  $t_{QH}$  before the rising and after the falling edge of SCL, respectively. For reading data from the HTU31D sensor, DATA is valid  $t_{VD}$  after SCL has gone low and remains valid until the next falling edge of SCL.

An external pull-up resistor (e.g.  $10k\Omega^9$ ) on SCK is required to pull the signal high only for open collector or open drain technology microcontrollers. In most of the cases, pull-up resistors are internally included in I/O circuits of microcontrollers.

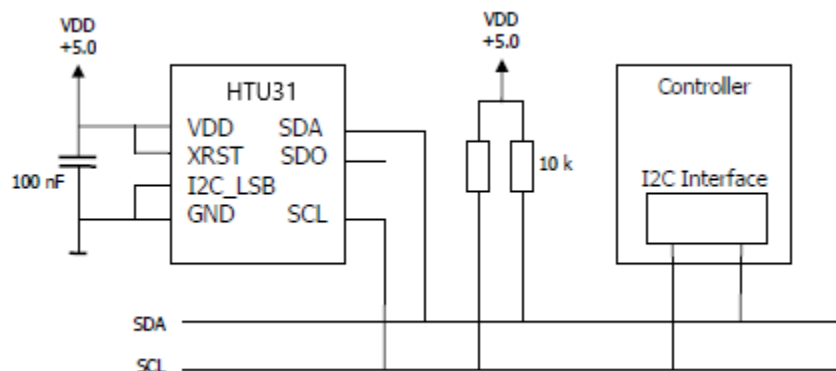

Figure 4 I2C Typical Application circuit: Address = 0x40

### Power Pins (VDD; GND)

Typical application circuit includes a 100nF decoupling capacitor between VDD and GND, placed as close as possible to the sensor.

<sup>9</sup> Pull-up resistor value is valid if the HTU is alone on I<sup>2</sup>C bus functioning @100kHz, other wise please refer to UM10204, Rev. 6, April 4, 2014

### IC\_Add Pin

The IC\_Add Pin allows the user to dynamically change the sensor I2C address and thus connect multiple sensors on the same I2C network. The level applied to the IC\_Add Pin must remain constant from the start to the end of the I2C communication. (see I2C chapter in communication and operation section for more details)

### RST

The RST pin can be used to generate a reset of the sensor. A minimum pulse duration of 1  $\mu$ s is required to reliably trigger a sensor reset. If it is not used, it is recommended to leave the floating pin or connect it to VDD with a series resistance of  $R \geq 2$  k $\Omega$ .

## COMMUNICATION AND OPERATION

### I2C Address

The HTU31 series has the capability to answer 2 distinct I2C addresses. This can be used to use multiple sensors on the same I2C network and avoid any address conflict with other components.

### Hardwired Dynamic address

The hardwired address is defined by the IC\_ADD pin level (it set the LSB value). It can be used to have 2 sensors on the same I2C network (one wired to VDD, the other to VSS). The other option to use more than 2 sensors on the same I2C network is to use individual IC\_ADD lines to the sensors.

IC_ADD Pin level	Sensor I2C address (Hex)
GND	0x40
VDD	0x41

Table 7 Sensor I2C Address

### Software address

The software address is not activated by default but can be set to any I2C valid address by our factory. Please contact our customer service if you wish to use this address.

### Input / Output characteristics

Characteristic	Symbol	Min	Max	Unit
Output Low Voltage	VOL	0.0 V <sub>DD</sub>	0.2 V <sub>DD</sub>	V
Output High Voltage	VOH	0.8V <sub>DD</sub>	V <sub>DD</sub>	V
Input High Voltage	VIH	0.7 VDD	VDD	V
Input Low Voltage	VIL	0.0 VDD	0.3 VDD	V

Table 8 Input and Output Characteristics



## HTU31D RH/T SENSOR IC

Digital Relative Humidity sensor with Temperature output

### Timing specifications of digital input/output pads for I<sup>2</sup>C fast mode

Characteristics	Symbol	Min	Typ	Max	Unit	Notes / Conditions
SCL frequency	f <sub>scl</sub>			10	MHz	
SCL high time	t <sub>low</sub>	40			ns	
SCL low time	t <sub>high</sub>	60			ns	
SCL setup to falling SDA	t <sub>su:sta</sub>	20			ns	repeated start
SCL hold to falling SDA	t <sub>hd:sta</sub>	20			ns	signaling start
SDA setup to SCL rising	t <sub>su:dat</sub>	20			ns	
SDA hold to SCL falling	t <sub>hd:dat</sub>	20			ns	SDA input
SDA delay to SCL falling	t <sub>su:dout</sub>		5	20	ns	SDA output, internal chip delay without loading

Table 9 Timing specification for I<sup>2</sup>C Fast mode

## Sensor Functions

Command Byte

	7	6	5	4	3	2	1	0
Command Name	CMD	CMD	CMD					Stop
Reset	0	0	0	1	1	1	1	X
Heater on	0	0	0	0	0	1	0	X
Heater off	0	0	0	0	0	0	1	X
Read T&RH	0	0	0	0	0	0	0	X
Read RH	0	0	0	1	0	0	0	X
Conversion	0	1	0	OSRRH1	OSRRH0	OSRT1	ORST0	X
Read Diagnostic	0	0	0	0	1	0	0	X
Read serial number	0	0	0	0	1	0	1	X

Table 10 User Commands

Measurement sequence

- 1) Launch a Conversion with the desired resolution: this will measure sensor environment and load measurement in sensor memory
- 2) Wait for the conversion time
- 3) Launch a Read T&RH or Read RH instruction to read measurement

Note: Humidity and temperature values are update by the conversion command.

**Conversion**

The conversion command triggers a single temperature and humidity conversion. The osr (selected resolution) is setup within the command:

abbreviation	binary value	Description
<b>osrRH1..osrRH0</b>	11	Humidity OSR = 3 (0.007%RH)
	10	Humidity OSR = 2 (0.010%RH)
	01	Humidity OSR = 1 (0.014%RH)
	00	Humidity OSR = 0 (0.020%RH)
<b>osrT1..osrT0</b>	11	Temperature OSR = 3 (0.012°C)
	10	Temperature OSR = 2 (0.016°C)
	01	Temperature OSR = 1 (0.025°C)
	00	Temperature OSR = 0 (0.040°C)

Table 11 Humidity and Temperature conversion parameters

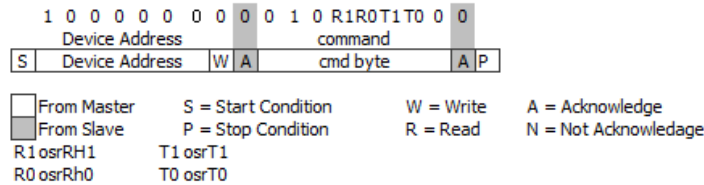

Figure 5 Conversion launch sequence

**Read T&RH**

The read command is used to either read only the temperature or both the temperature and the humidity. After the 16bit temperature data, an 8 bit CRC is following, as well as, after the 16 bit RH data, another 8 bit CRC is following.

The data reading can be stopped any time by just applying a not acknowledge (N) and stop sequence. This can be used, for example, if only the temperature data is needed.

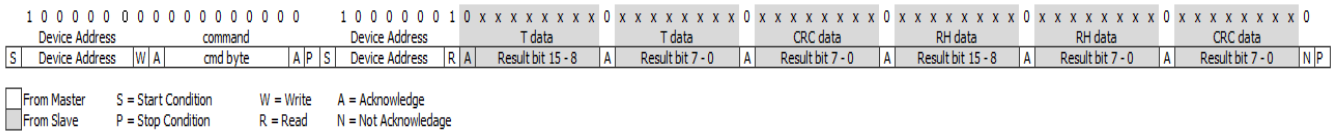

Figure 6 Read T&RH command

**Note:** The not acknowledge (N) and stop at the end of the reading is mandatory, otherwise the chip may block the SDA.

**Read RH**

This command is available in the case when only the relative humidity (RH) data is needed. Also, here, the 16 RH data bits are followed by an 8 bit CRC. When the CRC is not required, it's possible to stop after the 16 RH data bits were received, by sending a not acknowledge (N) and stop sequence:

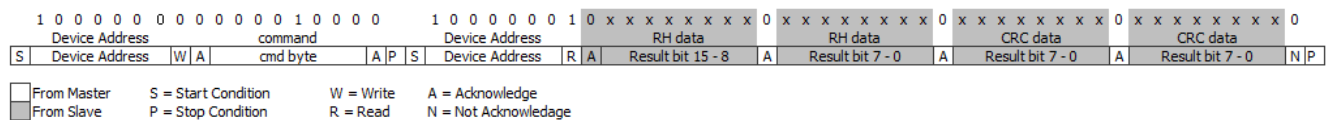

Figure 7 Read RH Command

**Reset**

## HTU31D RH/T SENSOR IC

Digital Relative Humidity sensor with Temperature output

This command is used for rebooting the HTU31D sensor switching the power off and on again. Upon reception of this command, the HTU31D sensor system reinitializes and starts operation according to the default settings. The soft reset takes less than 5 ms.

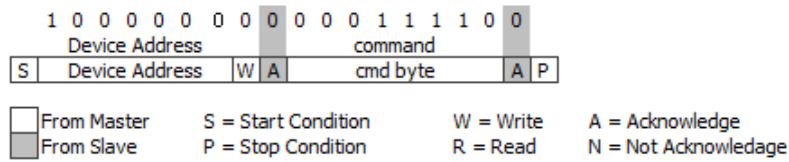

Figure 8 Soft reset command

### Heater on

There's a built-in heater which can be switched on by the following command:

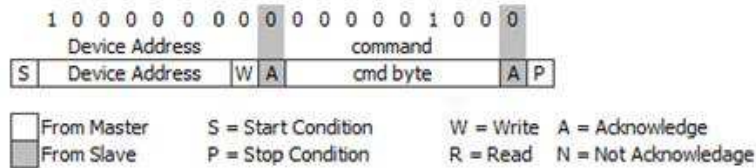

Figure 9 Heater on command

### Heater off

To switch the heater off, a reset or the following command has to be applied:

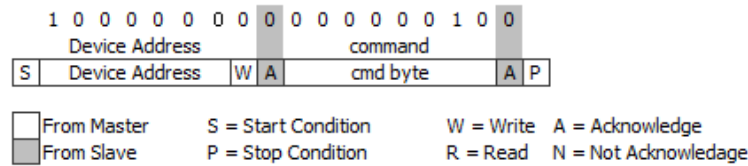

Figure 10 Heater off command

### Read Diagnostic

There's a diagnostic register available, which allows to check if the humidity and temperature are completely failing, if the humidity or temperature are out of specified range, the heater and the memory status:

#### Diagnostic Register

7	6	5	4	3	2	1	0
<b>NVM error*</b>	Humidity under/overrun	Humidity high error	Humidity low error	Temperature under/overrun	Temperature high error	Temperature low error	Heater on

Table 12 Diagnostic register

## HTU31D RH/T SENSOR IC

Digital Relative Humidity sensor with Temperature output

Abbreviation	Description
<b>NVM error</b>	bit is set if the CRC of the NVM has failed (CRC is done on the register copy)
<b>Humidity under/overrun</b>	bit is set if the humidity is truncated to 0 or the max value of $2^{16}-1$
<b>Humidity low error</b>	bit is set if the humidity calculation results below -10 %RH
<b>Humidity high error</b>	bit is set if the humidity calculation results above 120 %RH
<b>Temperature under/overrun</b>	bit is set if the temperature is truncated to 0 or the max value of $2^{16}-1$
<b>Temperature low error</b>	bit is set if the temperature calculation results below -50 °C
<b>Temperature high error</b>	bit is set if the temperature calculation results above 150 °C
<b>Heater on</b>	bit is set if the heater is on

Table 13 Diagnostic register bits

### Read serial number

For identification of the chip, the serial number can be read. The 24 bit serial number data is followed by an 8 bit CRC:

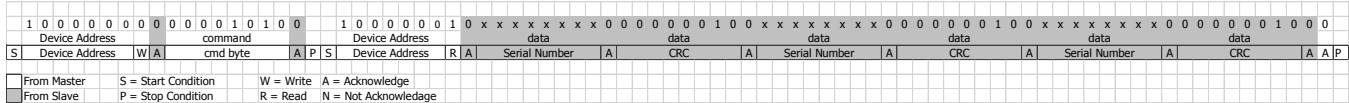

## CRC

### CRC Checksum

HTU31D sensor provides a CRC-8 checksum for error detection. The polynomial used is  $X^8 + X^5 + X^4 + 1$ .

### Basic Considerations

CRC stands for Cyclic Redundancy Check. It is one of the most effective error detection schemes and requires a minimal amount of resources.

The types of errors that are detectable with CRC that is implemented in HTU31D sensors are:

- Any odd number of errors anywhere within the data transmission
- All double-bit errors anywhere within the transmission
- Any cluster of errors that can be contained within an 8-bit window (1-8 bits incorrect)
- Most larger clusters of errors

A CRC is an error-detecting code commonly used in digital networks and storage devices to detect accidental changes to raw data.

Blocks of data entering these systems get a short check value attached, based on the remainder of a polynomial division of their contents; on retrieval the calculation is repeated, and corrective action can be taken against presumed data corruption if the check values do not match.

CRCs are so called because the check (data verification) value is a redundancy (it expands the message without adding information) and the algorithm is based on cyclic codes. CRCs are popular because they are simple to implement in binary hardware, easy to analyze mathematically, and particularly good at detecting common errors caused by noise in transmission channels. Because the check value has a fixed length, the function that generates it is occasionally used as a hash function.

### CRC for HTU31D

When HTU31D sensors are run by communicating with the standard I<sup>2</sup>C protocol, an 8-bit CRC can be used to detect transmission errors. The CRC covers all read data transmitted by the sensor. CRC properties for HTU31D sensors communicating with I<sup>2</sup>C protocol are listed in the table below.

CRC with I <sup>2</sup> C protocol	
Generator polynomial	$X^8 + X^5 + X^4 + 1$
Initialization	0x00
Protected data	Read data
Final Operation	none

*Table 14 I<sup>2</sup>C CRC Properties*

### CRC calculation

To compute an n-bit binary CRC, line the bits representing the input in a row, and position the (n+1)-bit pattern representing the CRC's divisor (called a "polynomial") underneath the left-hand end of the row.

This is first padded with zeroes corresponding to the bit length n of the CRC.

If the input bit above the leftmost divisor bit is 0, do nothing. If the input bit above the leftmost divisor bit is 1, the divisor is XORed into the input (in other words, the input bit above each 1-bit in the divisor is toggled). The divisor is then shifted one bit to the right, and the process is repeated until the divisor reaches the right-hand end of the input row.

Since the left most divisor bit zeroed every input bit it touched, when this process ends the only bits in the input row that can be nonzero are the n bits at the right-hand end of the row. These n bits are the remainder of the division step and will also be the value of the CRC function.

The validity of a received message can easily be verified by performing the above calculation again, this time with the check value added instead of zeroes. The remainder should equal zero if there are no detectable errors.

### CRC examples

The input message 11011100 (0xDC) will have as result 01111001 (0x79).

The input message 01101000 00111010 (0x683A) will have as result 01111100 (0x7C).

The input message 01001110 10000101 (0x4E85) will have as result 01101011 (0x6B).

## CONVERSION OF SIGNAL OUTPUTS

Measurement data are always transferred as 16-bit values (unsigned integer). Converting those raw values into a physical measurement can be achieved using the following formulas.

### Relative Humidity conversion

With the relative humidity signal output  $S_{RH}$ , the relative humidity is obtained by the following formula (result in %RH), no matter which resolution is chosen:

$$RH = 100 \times \frac{S_{RH}}{2^{16} - 1}$$

### Temperature conversion

The temperature  $T$  is calculated by inserting temperature signal output  $S_T$  into the following formula (result in °C), no matter which resolution is chosen:

$$T = -40 + 165 \times \frac{S_T}{2^{16} - 1}$$

Note: these formulas are valid for decimal representation of  $S_T$  and  $S_{RH}$

# HTU31D RH/T SENSOR IC

Digital Relative Humidity sensor with Temperature output

## PACKAGING INFORMATION

### Package outline

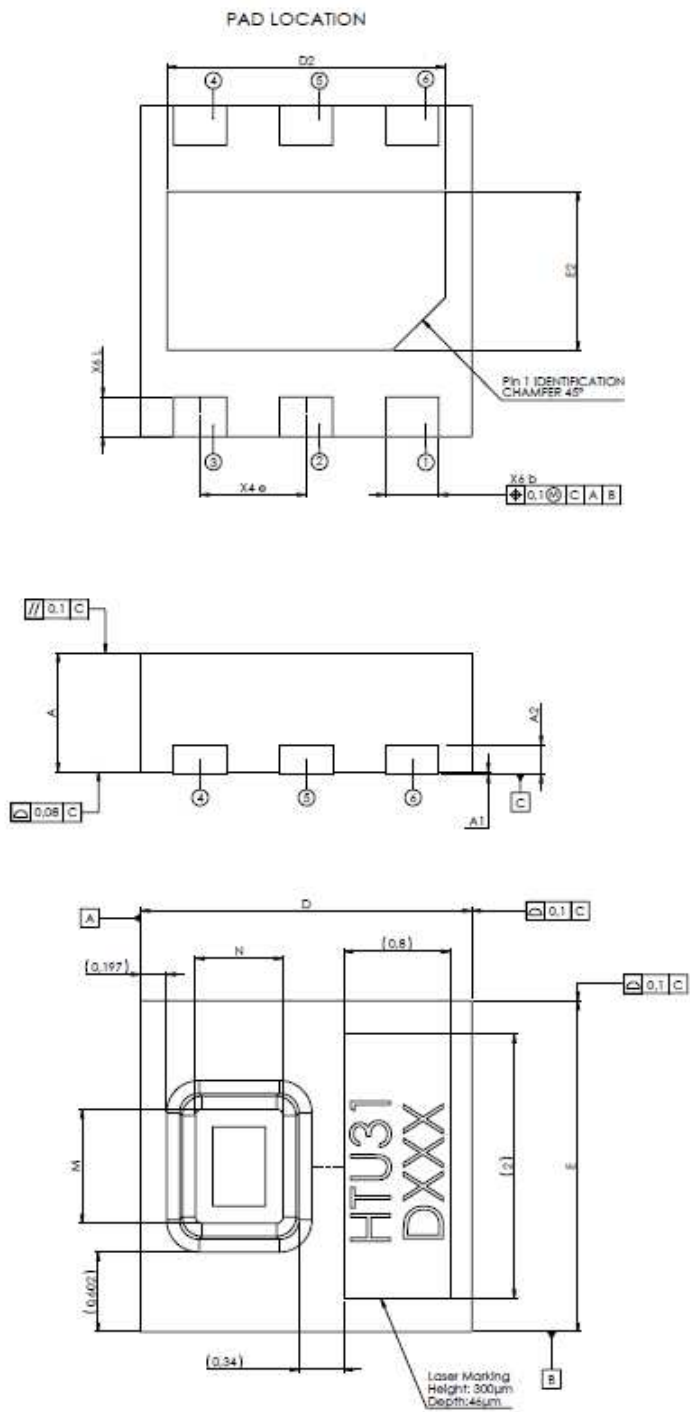

SYMBOL	COMMON					
	DIMENSIONS MILLIMETER			DIMENSIONS INCH		
	MIN.	NOM.	MAX.	MIN.	NOM.	MAX.
A	0.85	0.90	0.95	0.033	0.035	0.037
A1	0.00	0.02	0.05	0.000	0.001	0.002
A2	0.203 REF			0.008 REF		
b	0.35	0.40	0.45	0.014	0.016	0.018
D	2.45	2.50	2.55	0.096	0.098	0.100
D2	2.05	2.10	2.15	0.081	0.083	0.085
E	2.45	2.50	2.55	0.096	0.098	0.100
E2	1.15	1.20	1.25	0.045	0.047	0.049
e	0.80 BSC			0.031 BSC		
L	0.25	0.30	0.35	0.010	0.012	0.014
M	0.860 REF			0.034 REF		
N	0.660 REF			0.026 REF		

## HTU31D RH/T SENSOR IC

Digital Relative Humidity sensor with Temperature output

### Packaging Type

HTU31D sensors are provided in DFN type package. DFN stands for Dual Flat No leads.

The HTU31D sensor chip is mounted to a lead frame made of Cu and plated with Ni/Pd/Au.

### Traceability Information

All HTU31D sensors are laser marked with an alphanumeric, six-digit code on the sensor as pictured below.

The marking on the HTU31D sensor consists of two lines with five digits each:

- The first line denotes the sensor type: HTU31.
- The second line denotes several information as:
- The first digit of the second line defines the output mode:
  - D = Digital and I<sup>2</sup>C
  - V = Analog
- The second and third digits define the manufacturing year: 19=2019, 20=2020.
- The last three digits represent an alphanumeric tracking code. That code represents the day of the year.

Reels are also labeled, as displayed below and give additional traceability information.



With:

3X:	Sensor Type (31 for HTU31)
Y:	Output mode (V = Analog)
TTTTTTTTT:	MEAS Traceability Code
QQQQ:	Quantity per reel (400, 1500 or 5000 units)
YY:	Last two digits of the year
DDD:	Day of the year



# HTU31D RH/T SENSOR IC

Digital Relative Humidity sensor with Temperature output

## Tape and Reel Packaging

HTU31D sensors are shipped in tape & reel packaging, sealed into antistatic ESD bags.

Standard packaging sizes are 400, 1500 and 5000 units per reel. Each reel contains 440mm (55 pockets) header tape and 200mm (25 pockets) trailer tape. The drawing of the packaging tapes with sensor orientation is shown in the picture below.

For 400 and 1500 units: outside diameter of 7" (178mm) and a 1/2" (13mm) diameter arbor hole.

For 5000 units: outside diameter of 13" (330mm) and a 1/2" (13mm) diameter arbor hole.

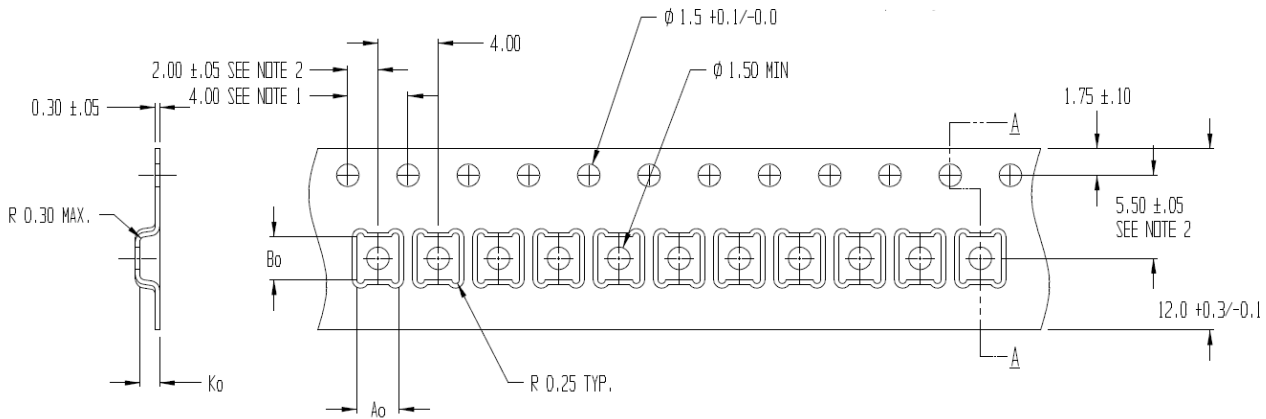

Table 15 Technical drawing of tape and reel

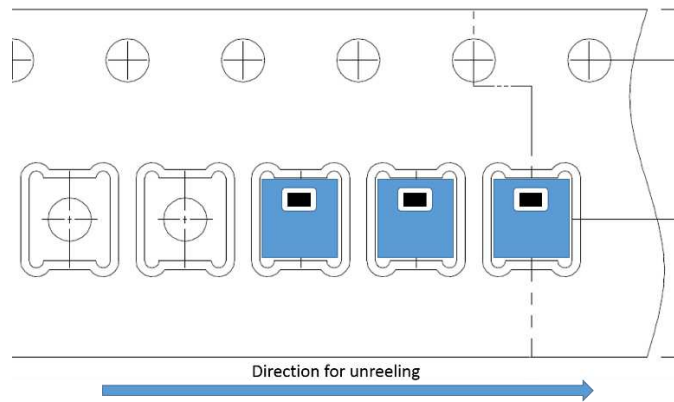

Figure 12 Product orientation in tape and reel packaging

## Recommended footprint for PCBa assembly

All dimensions are in mm

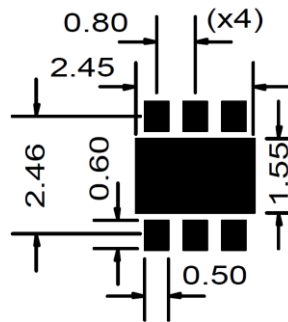

Figure 13 Recommended footprint

### Handling / Storage recommendations

In order to use and preserve the high quality performance of the HTU31 humidity and temperature sensor, the following recommendations have to be followed concerning storage and packaging.

Please read the paragraph below carefully and note that all precautions are applicable for design phases, production phases as well as in case of returned material to Measurement Specialties.

When sensors are not used or assembled, we recommend storing them in their original sealed anti ESD packaging. If sensors have been removed from their original packaging, we recommend keeping them in anti-static shielded ESD bags.

Such SMD sensors are classified MSL level 1 according to IPC/JEDEC J-STD-020.1 for storage, packaging and handling.

We recommend a shelf life of 1 year in following conditions of temperature and relative humidity  $\leq 30^{\circ}\text{C}$  85%RH.



Protection against ESD mandatory

## HTU31D RH/T SENSOR IC

Digital Relative Humidity sensor with Temperature output

## QUALITY

Qualification of HTU31 is performed based on AEC Q 100 grade 1 standard.

## MATERIAL CONTENT

The device is fully RoHS and REACH compliant.

## ORDERING INFORMATION

HTU31X

Output Signal	
Code	Output Type
D	I <sup>2</sup> C Digital
V	Radiometric voltage

Description	Quantity	Part number
HTU31D I.C 31D RH/T DIGITAL R400	400	10142048-00
HTU31D I.C 31D RH/T DIGITAL R1500	1500	10142048-01
HTU31D I.C 31D RH/T DIGITAL R5000	5000	10142048-02
HTU31V I.C 31V RH/T ANALOG R400	400	10142048-10
HTU31V I.C 31V RH/T ANALOG R1500	1500	10142048-11
HTU31V I.C 31V RH/T ANALOG R5000	5000	10142048-12

### REVISION HISTORY

DATE	VERSION	PAGE(S)	CHANGES
November 2019	1		-

### NORTH AMERICA

Tel +1 800 522 6752  
[customercare.hmpt@te.com](mailto:customercare.hmpt@te.com)

### EUROPE

Tel +31 73 624 6999  
[customercare.ftse@te.com](mailto:customercare.ftse@te.com)

### ASIA

Tel +86 0400 820 6015  
[customercare.shzn@te.com](mailto:customercare.shzn@te.com)

### [te.com/sensorsolutions](http://te.com/sensorsolutions)

MEAS, TE Connectivity, TE, and the TE connectivity (logo) are trademarks owned or licensed by the TE Connectivity Ltd. family of companies. Other logos, products and/or company names referred to herein may be trademarks of their respective owners.

The information given herein, including drawings, illustrations and schematics which are intended for illustration purposes only, is believed to be reliable. However, TE Connectivity makes no warranties as to its accuracy or completeness and disclaims any liability in connection with its use. TE Connectivity's obligations shall only be as set forth in TE Connectivity's Standard Terms and Conditions of Sale for this product and in no case will TE Connectivity be liable for any incidental, indirect or consequential damages arising out of the sale, resale, use or misuse of the product. Users of TE Connectivity products should make their own evaluation to determine the suitability of each such product for the specific application.

© 2019 TE Connectivity All Rights Reserved.